

# Инструкция по сборке гроутента

1 Соедините каркас гроутента, убедившись, что стойки правильно вошли в угловые разъемы.  
 Может потребоваться осторожно покрутить стойки вперед-назад, пока соединительные вставки не выдвинутся и не зафиксируются.

Размер (см)	Трубка1(A)	Трубка2(A)	Трубка3(B)	Трубка4(C)	Трубка5(E)	Трубка6(F)
240x120x200	x8	x5	x6	x6	x2	x2
300x150x200	x8	x5	x6	x6	x2	x2

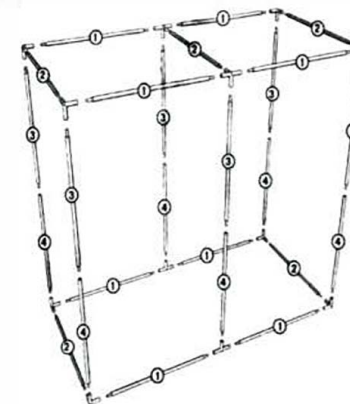
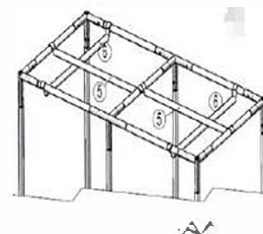

Размер (см)	Трубка1(A)	Трубка2(A)	Трубка3(B)	Трубка4(C)	Трубка5(E)	Трубка6(F)
50x50x100	x4	x4	x4	x4	x1	x1
60x60x60	x4	x4	x4	x0	x1	x1
60x60x120	x4	x4	x4	x4	x1	x1
60x60x140	x4	x4	x4	x4	x1	x1
60x60x160	x4	x4	x4	x4	x1	x1
80x80x160	x4	x4	x4	x4	x1	x1
80x80x180	x4	x4	x4	x4	x1	x1
90x60x100	x4	x4	x4	x4	x1	x1
90x90x180	x4	x4	x4	x4	x1	x2
90x90x200	x4	x4	x4	x4	x1	x2
100x100x180	x4	x4	x4	x4	x1	x2
100x100x200	x4	x4	x4	x4	x1	x2
120x60x150	x4	x4	x4	x4	x1	x2
120x120x200	x4	x4	x4	x4	x1	x2
140x140x200	x4	x4	x4	x4	x1	x2
150x90x200	x4	x4	x4	x4	x1	x2
150x150x200	x4	x4	x4	x4	x1	x2
40x40x120	x4	x4	x4	x4	x1	x1
90x50x160	x4	x4	x4	x4	x1	x1
100x50x200	x4	x4	x4	x4	x1	x2
70x70x200	x4	x4	x4	x4	x1	x1
80x45x80	x4	x4	x4	x0	x1	x1

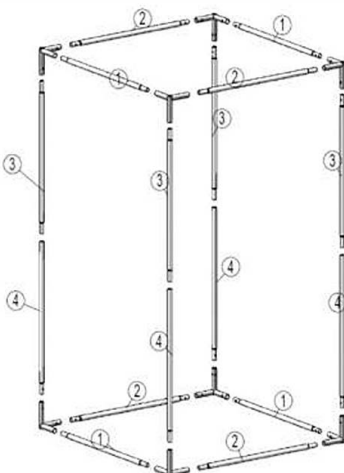
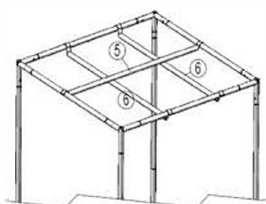
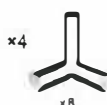

Размер (см)	Трубка1(A)	Трубка2(A)	Трубка3(B)	Трубка4(C)	Трубка5(E)	Трубка6(F)
200x200x200	x10	x12	x9	x9	x4	x4
240x240x200	x10	x12	x9	x9	x4	x4
360x240x200	x10	x12	x9	x9	x4	x4
300x300x200	x10	x12	x9	x9	x4	x4

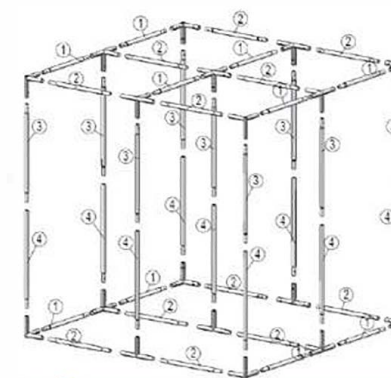
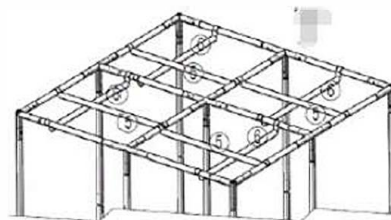
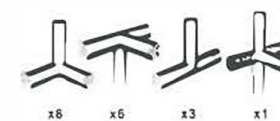

Натяните полотно грунтоента на собранный каркас.

